

MV-1 MINI-VAC

Electrically operated Cleanroom Vacuum Cleaner System
MODEL MV-1 CR HH-CC (suitable for Pharmaceutical applications)



- Compatible with ISO Class 4 (Former Class 10) Cleanroom conditions. Suitable for pharmaceutical applications.
- ULPA Filter efficiency of 99.999% @ 0.12 micron. Tested: IEST RP-CC001.3. Filtration efficiency of 99.9995% @ 0.18 micron. Tested: IEST RP-CC001.3. U15 by MPPS method as per EN 1822.
- All Stainless Steel AISI 304 construction.
- EMI/RFI suppressor.
- Static free (ESD Safe). Designed to be grounded during use. The electrical resistivity is less than 10 ohms. Any static produced while vacuuming is quickly and effectively discharged to the ground.
- Designed for a variety of cleanroom environments and mini environments, including :
 - Semiconductor/Microelectronic
 - Pharmaceutical

Characteristics:



ULPA
ULPA filter



Cleanroom compatible



Pharmaceutical applications



Static dissipating conductive



Stainless Steel



Toolkit included



Tiger-Vac®
...The name to vacuum with

Tiger-Vac Inc. (USA)
 73 S.W. 12 Ave. Bldg. 1, Unit 7
 Dania, FL 33004
 USA
 Tel.: (954) 925-3625
 Fax.: (954) 925-3626
 E-mail: sales@tiger-vac.com

Tiger-Vac International Inc.
 2020 Dagenais Blvd. West
 Laval, Quebec
 Canada H7L 5W2
 Tel.: (450) 622-0100
 Fax.: (450) 625-3388
 E-mail: support@tiger-vac.com

Toll free telephone: 1 800 668-4437 (Fax: 1 800 668-4439)
<http://www.tiger-vac.com>

Performance chart

Model	Phase/Volts 60 Hz	Electric current	Electric Power	Airflow	Vacuum at sealed orifice	Recovery capacity	Noise level
MV-1 CR HH-CC	1/120	6.5 A	1 HP	110 CFM	63" H ₂ O	0.5 Gal*	64 dB9(A) at 6.5'
Dimensions: 7.5" (diam) X 21" (length) (19cm X 53 cm). Power cord length: 35' (10.6m)						Weight: 11 lbs (5kg)	

ESD Safe Tools and accessories provided with the MV-1 CR HH:



1. Mini-Vac, lightweight, Stainless Steel AISI 304
2. Detachable Power cord 35'
3. Suction Hose 5', SD*
4. Extension wand, stainless steel AISI 304, SD*
5. Crevice tool, SD*
6. Flat tool, SD*
7. Round Brush, SD*
8. Reducer, Micro tool kit
9. Extension tips, SD*
10. Round Brush, SD*
11. Long Small brush tips, SD*
12. Crevice long tips, SD*

13. Main Cloth filter
14. ULPA Filter, eff. 99.999% @ 0,12µ
15. Disposable Paper filter bags (pkg. 5)
16. Carrying Case
17. Shoulder Strap

Items 9 to 13 are part of the microtool kit
Total kit weight: 30lbs (13.5kg)

*SD: Static Dissipating

Mini-Vac Filtration system

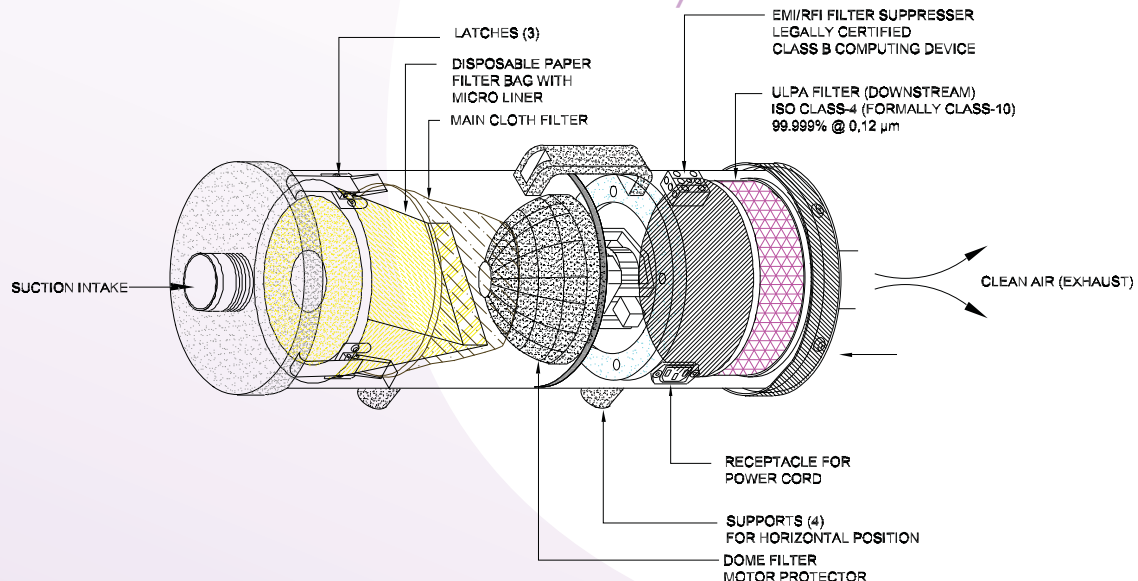

For complete details please visit our website: WWW.TIGER-VAC.COM or contact one of our technical representatives.
 Specifications are subject to change without notice. Images are for illustration purposes only. Tiger-Vac is a registered trademark.